

19,3

A

B

Nur bis hier nähen!
Only sew to this point

Nur bis hier nähen!
Only sew to this point

DIY Sewing Academy
SIMPLE DRAWSTRING BAG W37cmxH40cm
Vorder- & Rückseite / front & back
(2) Stoff Außen - exterior fabric

Dieses Schnittmuster wurde von Katja Ehrhardt für die DIY Sewing Academy entworfen. Die kommerzielle Nutzung ist verboten. ©2015
This pattern was created by Katja Ehrhardt for the DIY Sewing Academy. Commercial use is prohibited. ©2015

C

D

44,8

E

F

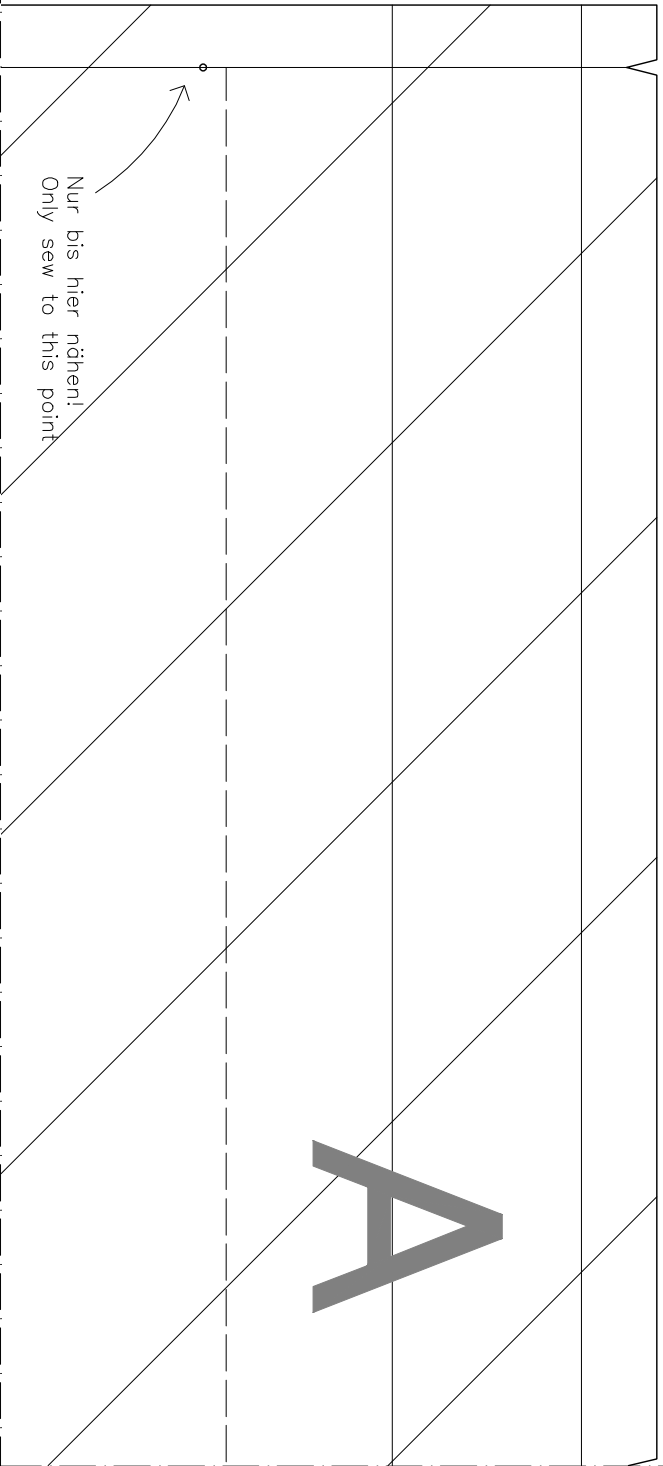
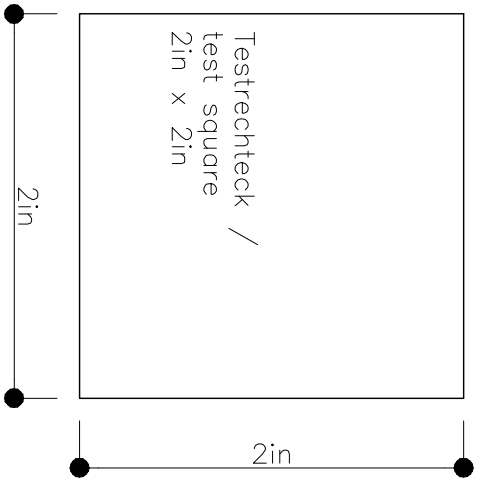
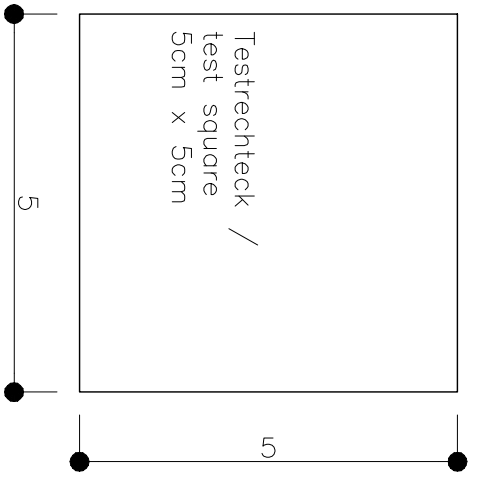

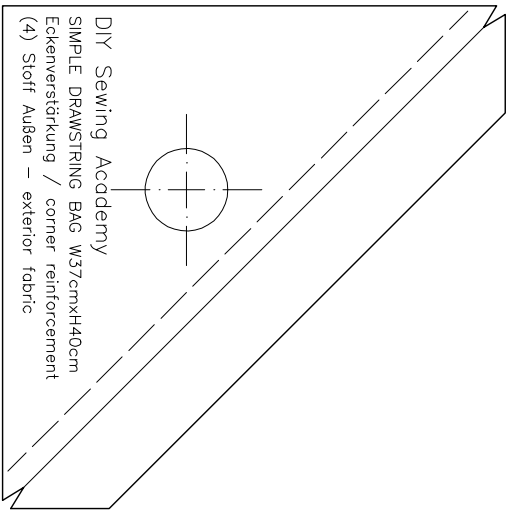

19,3

B

Nur bis hier nähen!
Only sew to this point

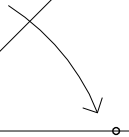

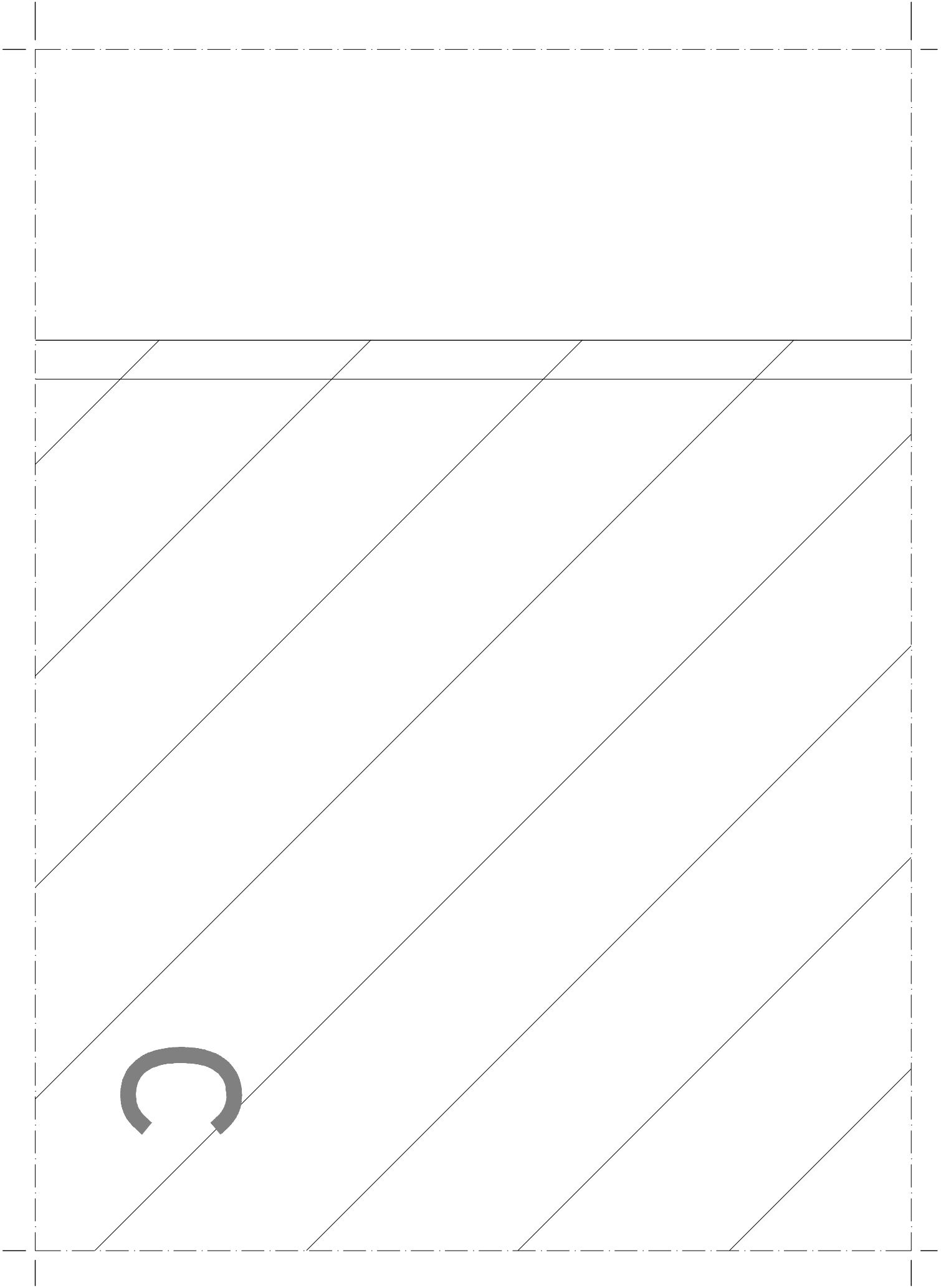

DIY Sewing Academy

SIMPLE DRAWSTRING BAG W37cmxH40cm

Vorder- & Rückseite / front & back

(2) Stoff Außen – exterior fabric

Dieses Schnittmuster wurde von Kasia Ehrhardt für die DIY Sewing Academy entworfen. Die kommerzielle Nutzung ist verboten. ©2015

This pattern was created by Kasia Ehrhardt for the DIY Sewing Academy. Commercial use is prohibited. ©2015



44,8

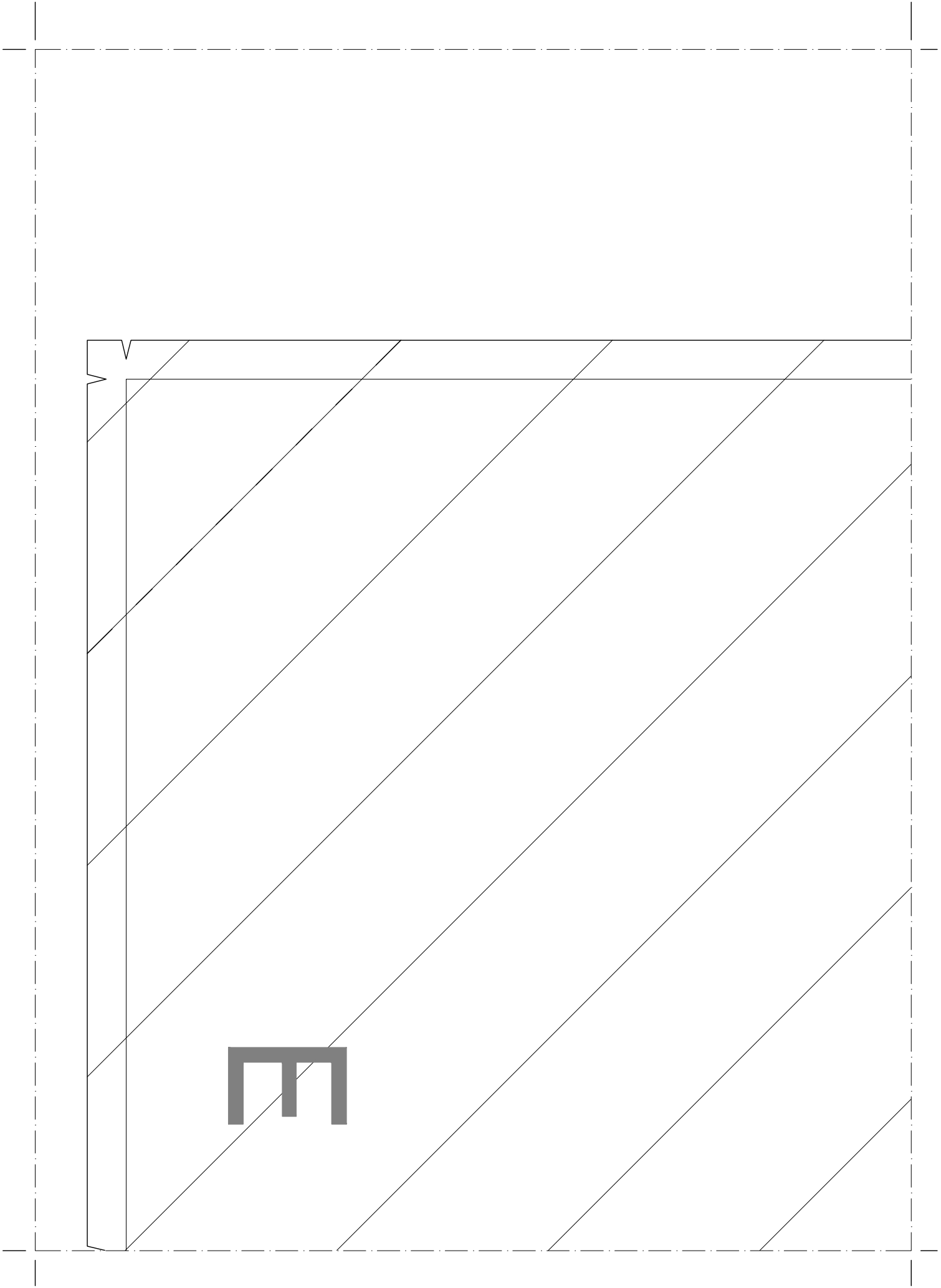

3

